

## Trademarks

Autel®, MaxiSys®, MaxiDAS®, MaxiScan®, MaxiCheck®, and MaxiRecorder® are trademarks of Autel Intelligent Technology Corp., Ltd., registered in China, the United States and other countries. All other marks are trademarks or registered trademarks of their respective holders.

## Copyright Information

No part of this manual may be reproduced, stored in a retrieval system or transmitted, in any form nor by any means, electronic, mechanical, photocopying, recording, nor otherwise without the prior written permission of Autel.

## Disclaimer of Warranties and Limitation of Liabilities

All information, specifications and illustrations in this manual are based on the latest information available at the time of printing.

Autel reserves the right to make changes at any time without notice. While information of this manual has been carefully checked for accuracy, no guarantee is given for the completeness and correctness of the contents, including but not limited to the product specifications, functions, and illustrations.

Autel will not be liable for any direct, special, incidental, indirect damages nor any economic consequential damages (including the loss of profits).

---

### IMPORTANT

Before operating or maintaining this unit, please read this manual carefully, paying extra attention to the safety warnings and precautions.

---

## For Services and Support



[pro.autel.com](http://pro.autel.com)

[www.autel.com](http://www.autel.com)



1-855-288-3587/1-855-AUTELUS (North America)

0086-755-86147779 (China)



[Support@autel.com](mailto:Support@autel.com)

For technical assistance in all other markets, please contact your local selling agent.

## Safety Information

---

For your own safety and the safety of others, and to prevent damage to the device and vehicles upon which it is used, it is important that the safety instructions presented throughout this manual be read and understood by all persons operating or coming into contact with the device.

There are various procedures, techniques, tools, and parts for servicing vehicles, as well as in the skill of the person doing the work. Because of the vast number of test applications and variations in the products that can be tested with this equipment, we cannot possibly anticipate or provide advice or safety messages to cover every circumstance. It is the automotive technician's responsibility to be knowledgeable of the system being tested. It is crucial to use proper service methods and test procedures. It is essential to perform tests in an appropriate and acceptable manner that does not endanger your safety, the safety of others in the work area, the device being used, or the vehicle being tested.

Before using the device, always refer to and follow the safety messages and applicable test procedures provided by the manufacturer of the vehicle or equipment being tested. Use the device only as described in this manual. Read, understand, and follow all safety messages and instructions in this manual.

## Safety Messages

---

Safety messages are provided to help prevent personal injury and equipment damage. All safety messages are introduced by a signal word indicating the hazard level.

---

### **DANGER**

Indicates an imminently hazardous situation which, if not avoided, will result in death or serious injury to the operator or to bystanders.

---

---

### **WARNING**

Indicates a potentially hazardous situation which, if not avoided, could result in death or serious injury to the operator or to bystanders.

---

## Safety Instructions

---

The safety messages herein cover situations Autel is aware of. Autel cannot know, evaluate or advise of all the possible hazards. You must be certain that any condition or service procedure encountered does not jeopardize your personal safety.

---

 **DANGER**

When an engine is operating, keep the service area WELL VENTILATED or attach a building exhaust removal system to the engine exhaust system. Engines produce carbon monoxide, an odorless, poisonous gas that causes slower reaction time and can lead to serious personal injury or loss of life.

---

 **SAFETY WARNINGS**

- Wear safety glasses and protective clothing.
- NEVER smoke or allow a spark or flame in vicinity of battery or engine.
- Have plenty of fresh water and soap nearby in case battery acid contacts skin, clothing or eyes.
- If battery acid contacts skin or clothing, wash immediately with soap and water. If acid enters eye, immediately flush eye with cold running water for at least ten minutes and get medical attention immediately.
- Use caution when working with metallic tools to prevent sparks or short circuits.
- Remove any jewelry or watches before you start servicing the battery.
- Keep hair, hands, and clothing as well as tester leads and cords away from moving blades and belts.

# CONTENTS

	<b>SAFETY INFORMATION</b> .....	ii
	<b>SAFETY MESSAGES</b> .....	ii
	<b>SAFETY INSTRUCTIONS</b> .....	ii
<b>1</b>	<b>USING THIS MANUAL</b> .....	1
	CONVENTIONS .....	1
<b>2</b>	<b>GENERAL INTRODUCTION</b> .....	3
	2.1 MAXIBAS BT508 TESTER .....	4
	2.1.1 <i>Function Description</i> .....	4
	2.1.2 <i>Power Sources</i> .....	5
	2.1.3 <i>Technical Specifications</i> .....	6
	2.2 MAXIVCI V200P — VEHICLE COMMUNICATION INTERFACE .....	7
	2.2.1 <i>Function Description</i> .....	7
	2.2.2 <i>Power Sources</i> .....	8
	2.2.3 <i>Technical Specifications</i> .....	8
<b>3</b>	<b>Getting Started</b> .....	10
	3.1 POWER UP .....	10
	3.1.1 <i>Application Buttons</i> .....	12
	3.2 TEST PREPARATION .....	12
	3.2.1 <i>Inspect the Battery</i> .....	12
	3.2.2 <i>Connecting to a Battery</i> .....	13
<b>4</b>	<b>IN-VEHICLE TEST</b> .....	14
	4.1 START THE TEST .....	15
	4.1.1 <i>VCI Connection</i> .....	16
	4.1.2 <i>Confirm Vehicle Information</i> .....	18
	4.2 BATTERY TEST .....	20
	4.3 STARTER TEST .....	24
	4.4 GENERATOR TEST .....	25
<b>5</b>	<b>OUT-VEHICLE TEST</b> .....	27
	5.1 TEST PROCEDURE .....	27
	5.2 TEST RESULTS .....	28
<b>6</b>	<b>BATTERY CHANGE</b> .....	29
	6.1 REPLACE THE BATTERY .....	29
<b>7</b>	<b>BATTERY RESET</b> .....	31

7.1	AUTO REGISTRATION (AFTER BATTERY REPLACEMENT) .....	31
7.1.1	<i>BMS Reset</i> .....	32
7.1.2	<i>Electric Appliance Reset</i> .....	32
7.2	SPECIAL FUNCTIONS .....	33
7.3	BATTERY USAGE HISTORY (ONLY FOR BMW VEHICLES) .....	34
<b>8</b>	<b>DIAGNOSTICS</b> .....	36
8.1	AUTO SCAN .....	36
8.2	CONTROL UNITS .....	38
8.2.1	<i>ECU Information</i> .....	40
8.2.2	<i>Read Codes</i> .....	41
8.2.3	<i>Erase Codes</i> .....	42
<b>9</b>	<b>HISTORY</b> .....	43
<b>10</b>	<b>MALL</b> .....	44
<b>11</b>	<b>ME</b> .....	46
11.1	ORDER MANAGER .....	47
11.2	REPAIR REPORTS .....	47
11.3	DELETE VEHICLE .....	48
11.4	DATA LOGGING .....	48
11.5	VCI MANAGER .....	49
11.6	BAS MANAGER .....	49
11.7	SETTINGS .....	49
11.8	USER MANUAL .....	50
<b>12</b>	<b>MAINTENANCE AND SERVICE</b> .....	51
12.1	MAINTENANCE INSTRUCTIONS .....	51
12.2	TROUBLESHOOTING CHECKLIST .....	52
12.3	ABOUT BATTERY USAGE .....	52
12.4	SERVICE PROCEDURES .....	54
12.4.1	<i>Technical Support</i> .....	54
12.4.2	<i>Repair Service</i> .....	56
<b>13</b>	<b>COMPLIANCE INFORMATION</b> .....	57
<b>14</b>	<b>WARRANTY</b> .....	59

# 1

## Using This Manual

This manual contains device usage instructions.

Some illustrations shown in this manual may contain modules and optional equipment that are not included in your system. Contact your sales representative for availability of other modules and optional tools or accessories.

### Conventions

The following conventions are used.

#### **Bold Text**

Bold text is used to highlight selectable items such as buttons and menu options.

Example:

- Tap **OK**.

#### **Notes and Important Messages**

*Notes*

A **NOTE** provides helpful information such as additional explanations, tips, and comments.

Example:

---

 **NOTE**  
New batteries reach full capacity after approximately 3 to 5 charging and discharging cycles.

---

### *Important*

**IMPORTANT** indicates a situation which, if not avoided, may result in damage to the test equipment or vehicle.

Example:

---

**!** **IMPORTANT**  
Keep the cable away from heat, oil, sharp edges and moving parts. Replace damaged cables immediately.

---

## **Hyperlink**

Hyperlinks, or links, that take you to other related articles, procedures, and illustrations are available in electronic documents. Blue italic text indicates an internal link and blue underlined text indicates a website link or an email address link.

## **Illustrations**

Illustrations used in this manual are samples, the actual testing screen may vary for each vehicle being tested. Observe the menu titles and on-screen instructions to select the appropriate options.

# 2 General Introduction

## **MaxiBAS BT508**

### **Battery & Electrical System Tester**

The feature-rich MaxiBAS BT508 battery tester applies Adaptive Conductance, a technology that identifies low-capacity batteries. The BT508 can provide a quick health status check of the existing battery, register a new battery, and perform advanced battery and electrical system diagnosis. The BT508 package includes a tester with a clamp cable, a VCI device, and the Battery Test app. The Battery Test app is available for download from the Apple App Store or Google Play.



# 2.1 MaxiBAS BT508 Tester

## 2.1.1 Function Description

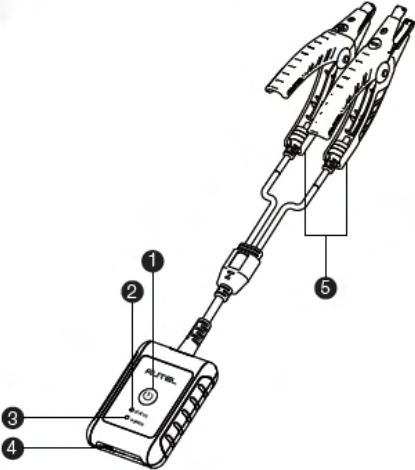

Figure 2-1 *MaxiBAS BT508*

- 1. Power Button
- 2. Status LED
- 3. Power LED
- 4. USB Port
- 5. Battery Clamp Cable

Table 2-1 LED Description

LED	Color	Description
<b>Status LED</b>	<b>Flashing Green</b>	The tester is communicating via USB cable.
	<b>Flashing Blue</b>	The tester is communicating via Bluetooth.
	<b>Flashing Red</b>	Battery clamps are connected to the wrong battery terminals.
<b>Power LED</b>	<b>Green</b>	<ul style="list-style-type: none"> <li>● <b>Solid Green:</b> The tester is powered on and the battery is sufficiently charged.</li> <li>● <b>Flashing Green:</b> The tester is charging. (Becomes solid green when battery is fully charged.)</li> </ul>
	<b>Red</b>	<ul style="list-style-type: none"> <li>● <b>Flashing Red:</b> The battery level is low. Please charge.</li> <li>● <b>Solid Red:</b> The device is in boot mode.</li> </ul>

## 2.1.2 Power Sources

The BT508 tester can receive power from the following sources:

- Internal battery pack
- AC/DC power supply

---

### **!** IMPORTANT

Do not charge the battery when the temperature is below 0°C (32°F) or above 45°C (113°F).

---

### Internal Battery Pack

The BT508 is powered via its internal rechargeable battery.

### AC/DC Power Supply — Using Power Adapter

The tester can be powered from an electrical outlet using the AC/DC power supply. The AC/DC power supply also charges the internal battery pack.

## 2.1.3 Technical Specifications

Item	Description
Connectivity	<ul style="list-style-type: none"><li>● USB 2.0, Type C</li><li>● Bluetooth 4.2</li></ul>
Input Voltage	5 V DC
Working Current	< 150 mA at 12 V DC
CCA Range	100 to 2000 A
Voltage Range	6 to 36 V
Working Temperature	-10 ° C to 50 ° C (14° F to 122° F)
Storage Temperature	-20 ° C to 60 ° C (-4° F to 140° F)
Dimension (L x W x H)	107 mm (4.21") x 75 mm (2.95") x 26 mm (1.02") (clamp cable not included)
Weight	320 g (0.7 lb.)

## 2.2 MaxiVCI V200P — Vehicle Communication Interface

### 2.2.1 Function Description

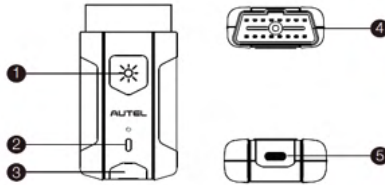

1. Flashlight Power Button
2. Power LED
3. Vehicle/Connection LED
4. Vehicle Data Connector (16-pin)
5. USB Port

*VCI LED Description*

LED	Color	Description
Power LED	Yellow	The VCI is powered on and performing self-check.
	Green	The VCI is ready for use.
	Flashing Red	The firmware is updating.
Vehicle / Connection LED	Green	<ul style="list-style-type: none"> <li>● <b>Solid Green:</b> The VCI is connected via USB cable.</li> <li>● <b>Flashing Green:</b> The VCI is communicating via USB cable.</li> </ul>
	Blue	<ul style="list-style-type: none"> <li>● <b>Solid Blue:</b> The VCI is connected via Bluetooth.</li> <li>● <b>Flashing Blue:</b> The VCI is communicating via Bluetooth.</li> </ul>

## 2.2.2 Power Sources

The VCI device can receive power from the following sources:

- Vehicle power
- AC/DC power supply

### Vehicle Power

The VCI device operates on 6 or 12 Volt vehicle power, which receives power via the vehicle data connection port. The device powers on whenever it is connected to an OBD II/EODB compliant data link connector (DLC).

### AC/DC Power Supply

The VCI device can be powered from a wall socket using the AC/DC power adapter. The user can charge the flashlight on the VCI by this way.

## 2.2.3 Technical Specifications

Item	Description
Communications	<ul style="list-style-type: none"><li>• BLE + EDR</li><li>• USB 2.0</li></ul>
Wireless Frequency	2.4 GHz
Input Voltage Range	6 to 36 V DC
Supply Current	150 mA @ 12 V DC
Operating Temperature	-10 °C to 50 °C (14 ° F to 122 ° F)
Storage Temperature	-40 °C to 80 °C (-40 ° F to 176 ° F)
Dimensions (L x W x H)	89.89 mm (3.53") x 46.78 mm (1.84") x 21 mm (0.82")

<b>Item</b>	<b>Description</b>
Weight	70.7 g (0.156 lb.)
Built-in Battery	3.7 V Lithium Battery
Light	White LED

# 3 Getting Started

Ensure that the unit is sufficiently charged.

---

## NOTE

1. The images and illustrations depicted in this manual may differ slightly from those displayed on your device. The user interfaces for iOS & Android devices might be slightly different. This manual depicts screens from the Android version of the app.
  2. The Battery Test app is compatible with 64-bit devices only.
- 

## 3.1 Power Up

### 1. Download and install app

Search for Battery Test in Google Play or the Apple App Store to download and install the app to your device or scan the QR code below to be directed to the Battery Test app download. On an Android device, you will be directed to Google Play, while iOS users will be directed to the Apple App Store.



### 2. Register and log in

- 1) Open the Battery Test app and tap **Register** on the **Log in** screen.
- 2) Follow the on-screen instructions to complete the registration.

- 3) Log in with your registered email address and password.

---

**NOTE**

If you already have an existing Autel account, log in with your registered Autel account email and password.

---

### 3. Pair the BT508

Pair the BT508 with the Battery Test app by scanning the QR code on the back of the tester or via Bluetooth pairing.

### 4. VCI Connection

Connect the VCI to the vehicle's DLC (OBD II port), usually located under the vehicle's dashboard. Follow the on-screen instructions to connect the VCI to the app on your device via Bluetooth.

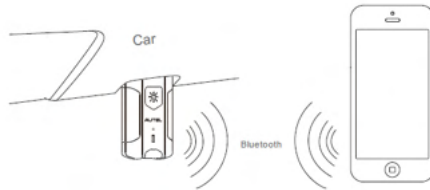







---

**NOTE**

1. It is recommended to pair your BT508 and VCI V200P by scanning the QR code on the back of the device. If you wish to connect the VCI to your mobile device via Bluetooth, the VCI must be inserted in the vehicle's DLC port first.
  2. On an Android device, Bluetooth can be enabled in **Settings** or in **BAS Manager** or **VCI manager**, while iOS users can only enable Bluetooth in **Settings**.
  3. Use the included USB cable to charge the flashlight of the V200P.
-



### 3.1.1 Application Buttons

Button	Name	Description
	In-vehicle test	Tests batteries that are installed in a vehicle. (See page 14.)
	Out-vehicle test	Tests batteries that are not installed in a vehicle. (See page 27.)
	Battery change	Operation guide for battery change. (See page 29.)
	Battery reset	Accesses the Battery reset function. (See page 31.)
	Diagnostics	Accesses the unit's diagnostics functions. (See page 36.)
	History	Accesses diagnostics and battery test results. (See page 43.)

## 3.2 Test Preparation

### 3.2.1 Inspect the Battery

Before starting a test, inspect the battery for:

- Cracking, buckling or leaking. If you see any of these defects, replace the battery.
- Corroded, loose or damaged cables and connections. Repair or replace as needed.

- Corrosion on the battery terminals and dirt or acid on the case top. Clean the terminals and the case top using a wire brush and a mixture of water and baking soda.

### 3.2.2 Connecting to a Battery

Press and hold the **Lock/Power** button to turn on the BT508.

Connect the red clamp to the positive (+) terminal and the black clamp to the negative (-) terminal of the battery.

The black clamp is installed with an infrared sensor near the clamp mouth that tests the battery temperature. The battery temperature will appear in the Battery Test Result screen or in the Battery Test Report.

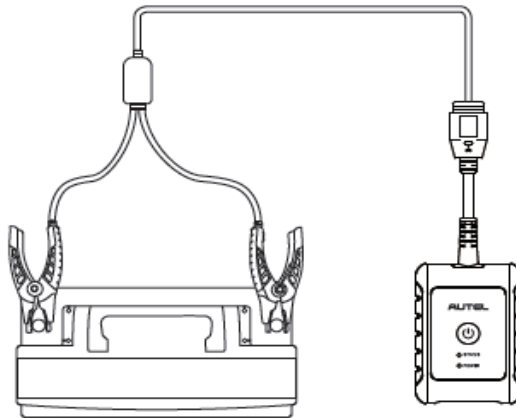

# 4 In-vehicle Test

The in-vehicle test is used for testing batteries that are installed in a vehicle. An in-vehicle test includes the Battery test, Starter test, and Generator test, and determines the health status of the battery, the starter, and the generator, respectively.

---

## ! IMPORTANT

1. Before using the diagnostic functions, ensure that the desired vehicle software has been downloaded from the **Mall** screen and, that the VCI is connected to your mobile device.
2. A Disclaimer page will appear when accessing any function on the **Home** screen for the first time. Please read the end user agreement and TAP **Accept** to continue. If you tap **Decline**, you will not be able to use the features properly.

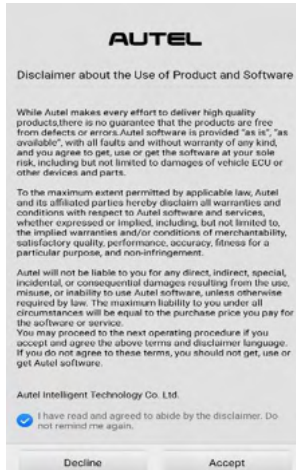

Figure 4-1 Sample Disclaimer Screen

## 4.1 Start the Test

Select **In-vehicle test** on the **Home** screen.

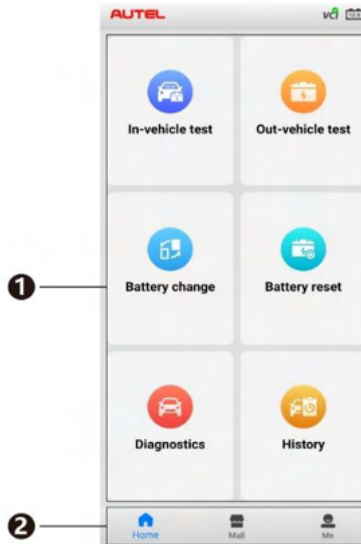



Figure 4-2 *Sample Home Screen*

1. **Home** screen — displays six major functions of the BT508, including In-vehicle test, Out-vehicle test, Battery change, Battery reset, Diagnostics, and History.
2. **Navigation Button** — displays **Home** screen, **Mall**, and **Me**. Via the **Mall**, the user can download the three software apps (Demo, Eobd and Battery Test) for free. All systems diagnostics software for additional brands may also be purchased via the Mall. The **Me** panel provides information related to the user account, including the Order Manager, Repair Report, Delete Vehicle, Data Logging, VCI Manager, BAS Manager, Settings, and User Manual.

## 4.1.1 VCI Connection

1. Connect the VCI to the vehicle's OBD II Data Link Connector (DLC).
2. Tap the  icon on the top-right corner to enter the VCI Manager menu. The device will automatically enable Bluetooth and start searching for available pairing units.
3. The device's name will appear on this menu as "Maxi" suffixed with a serial number starting with CFJP.
4. Check the serial number on your VCI label and select the desired device for pairing.
5. When paired successfully, the connection status is shown as **Paired**, and the vehicle/connection LED will light solid blue.

---

### NOTE

1. Step 2 is only applicable to Android users (iOS users cannot complete this operation).
  2. When entering the **VCI Manager** for the first time, an illustration showing possible locations for OBD II sockets will appear.
-

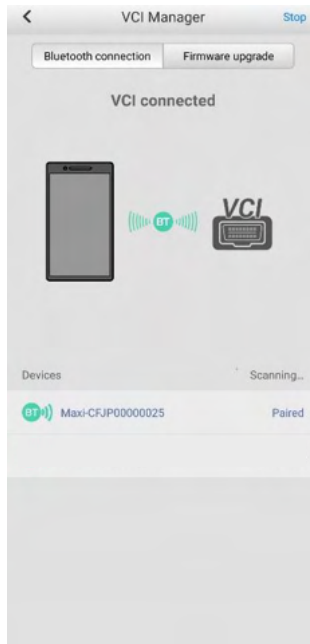

Figure 4-3 *Sample VCI Manager Screen*

6. Tap the < icon to return to the previous screen. The mobile device will switch to the Vehicle information screen. The **VCI** button on the top right corner of the screen will display a green check mark, indicating the mobile device is connected to the VCI.

## 4.1.2 Confirm Vehicle Information

Vehicle information

License: B5R95N

VIN: 1C4BJWFG5GL131334

Make: Jeep

Year: 2016

Model: JK-WRANGLER

Others: None

Battery Type	Battery Standard	Battery Capacity
FLOODED	CCA	100
AGM	SAE	105
AGM SPIRAL	CA	110

Battery location    Next

Figure 4-4 Sample Vehicle Information Screen

### Buttons

Name	Button	Description
<b>AutoVIN</b>		After the VCI is connected to the device through the vehicle's OBD II Data Link Connector (DLC), turn on the ignition. The vehicle's VIN will automatically be recognized.
<b>Battery Location</b>		Tap to view the battery location diagram.

- The vehicle information will be automatically identified when vehicle communication is established. A Battery Information tab will appear from the bottom of the screen.







Figure 4-5 Sample Battery Information Screen

- Tap the **X** icon on the tab to return to the Vehicle information screen. Tap **Battery Location** on the bottom left corner of the screen and view the battery position diagram.
- Find the battery, check the battery information on it and select the correct battery parameters on the screen.
- Confirm the information on the Vehicle information screen is accurate. Tap the corresponding field to manually correct the parameter values, if needed. Tap **Next** to continue.



## 4.2 Battery Test

Table 4-1 *Upper Toolbar Buttons*

Name	Button	Description
Back		Returns to the previous screen.
Exit		Returns to the Diagnosis (or Diagnostics) screen.
VCI Connection		Tap to enter the VCI Manager. The icon also displays the connection status of the VCI.
Battery Connection		Displays the battery connection status. The number on the icon indicates the real-time voltage of the tested battery.

### NOTE

On an Android device, a tap on the Battery Connection button will display the BAS Manager screen. On an iOS device, if the tester is not paired, a message will appear to prompt the user to pair the battery tester. No other action or screen will be displayed on the iOS device if already paired with the battery tester.

11. The Clamp Connection Diagram will appear. Follow the instructions to connect the clamp cables and tap **Next** to continue.

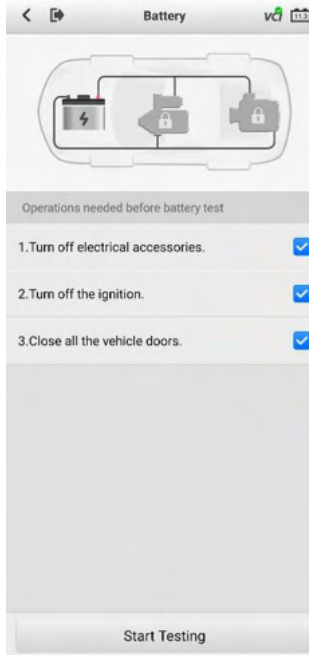

Figure 4-6 *Sample Battery Information Screen*

12. Follow the on-screen instructions, check the boxes and tap **Start Testing**.
13. Wait until the test is completed. The test results will appear as shown below:

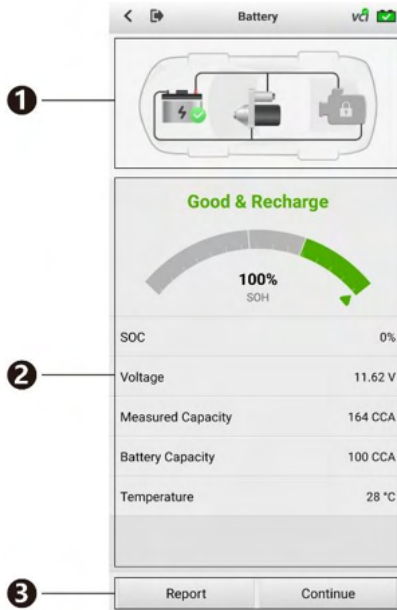

Figure 4-7 Sample Battery Test Result Screen

1. Process Buttons
2. Test Report
3. Function Buttons

### Process Buttons

Tap any of the process buttons to advance to the corresponding test — battery test, starter test or generator test. A status icon will appear on the bottom right corner of the button, indicating the test results.

### Battery Test Results

The battery test results include a color-coded results summary, a list of test data, and repair tips.

Table 4-2 *Battery Test Results*

<b>Result</b>	<b>Repair Tip</b>
Good Battery	Battery is good.
Good & Recharge	Battery is in good condition. The battery should be charged.
Charge & Retest	Charge the battery and retest.
Bad Cell	Replace the battery.
Replace Battery	Replace the battery.

### **Function Buttons**

The Function Buttons displayed at the bottom of the screen will vary depending on the operation. Functions include Report and Replace Battery. The table below provides a brief description of these operations:

<b>Name</b>	<b>Description</b>
<b>Report</b>	Tap to view the test data and results in report form. Tap <b>Print</b> on the bottom of the screen to print the test report to the built-in thermal printer. Tap <b>Email</b> to send the test results to an email address.
<b>Replace Battery</b>	Tap to continue to the Battery Change function if needed. See Battery Change on Page 29.
<b>Continue</b>	Tap to perform the next test.

### **NOTE**

Please always complete the Battery test before proceeding to the Starter and Generator tests.

## 4.3 Starter Test

14. Follow the on-screen instructions to complete the test. Start the engine and let it idle. The test results will be displayed as follows:

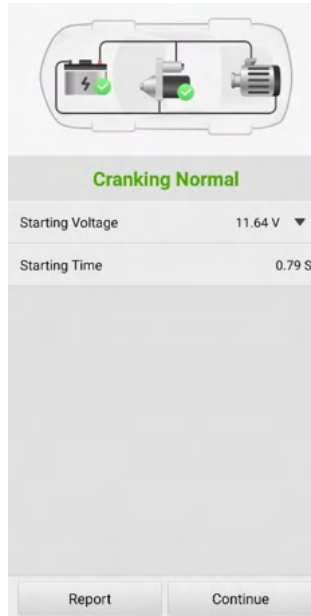

Figure 4-8 Sample Starter Test Results Screen

Table 4-3 Starter Test Results

Result	Description
Cranking Normal	Starter is good.
Current Too Low	Low momentary discharge capacity.
Voltage Too Low	Low battery storage capacity.
Not Started	Starter is not detected for starting.

## 4.4 Generator Test

15. Follow the on-screen instructions to complete the test. The test results will be displayed as follows:



Figure 4-9 Sample Generator Test Results Screen

Table 4-4 Generator Test Results

Result	Description
Charging Normal	The generator is good.
Output Too Low	<ul style="list-style-type: none"> <li>● The belt linking the starter and the generator is loose;</li> <li>● The cable linking the starter and battery is loose or corroded.</li> </ul>
Output Too High	<ul style="list-style-type: none"> <li>● The generator is not properly connected to the ground;</li> <li>● The voltage adjuster is broken and needs replacement.</li> </ul>
Ripple Too Large	The commutation diode is broken and needs repair or replacing.
No Output	<ul style="list-style-type: none"> <li>● The cable is loose.</li> <li>● Some vehicles with power management systems do not provide path for charging due to the sufficient load capacity of the battery;</li> <li>● The generator or the voltage adjuster is broken and needs replacing.</li> </ul>

# 5 Out-vehicle Test

Out-vehicle test is used to test the condition of batteries that are not connected to a vehicle. This function aims to check the health status of the battery only. The compatible battery types and standards are as follows:

**Types:** FLOODED, AGM, AGM SPIRAL, EFB, and GEL

**Standards:** CCA, SAE, CA, EN, EN2, IEC, DIN, JIS, MCA, BCI, and GB

## 5.1 Test Procedure

1. Connect the tester clamps to the battery terminals.
2. Select the appropriate battery type, rating standard, and capacity. Tap **Start Testing** to start the test.

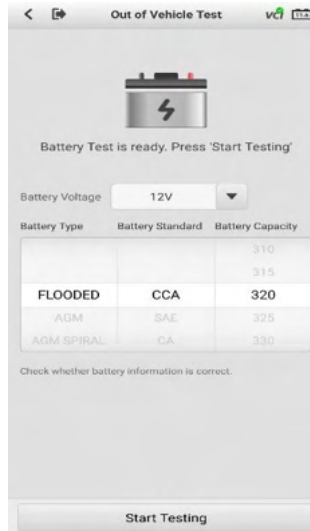

Figure 5-1 Sample Out-vehicle Test Screen



- The test results should be displayed in a few seconds.



Figure 5-2 Sample Out-vehicle Test Screen

## 5.2 Test Results

Icons are color-coded to indicate status.

Result	Description
Good Battery	Battery meets required standards.
Good & Recharge	Battery is good, but low on charge. Fully charge the battery. Check for causes of low charge.
Charge & Retest	Battery requires charge to determine its condition.
Replace Battery	Battery fails to meet industry-accepted standards.
Bad Cell	Battery fails to meet industry-accepted standards.

# 6 Battery Change

The Battery Change function guides you to replace the battery step by step. The battery replacement process includes Battery Type Suggestion, Preparation, Battery Replacement steps, New Battery Test and Battery Registration.

## 6.1 Replace the Battery

1. Tap the **Help** button at the bottom of each screen to read all the help information carefully before operation, then follow the on-screen instructions to complete the battery replacement.

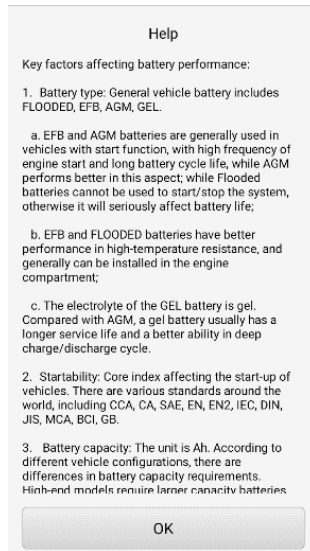

Figure 6-1 Sample Help Screen

2. To save the vehicle's onboard data when the vehicle's battery is removed or disconnected, we recommend using a memory saver (an optional accessory) to connect a spare battery to the vehicle.



Figure 6-2 Sample New Battery Test Results Screen

3. When the new battery test is completed, tap **Next** to automatically proceed to **Auto Registration** in the **Battery Reset** section.

# 7 Battery Reset

The Battery Reset allows users to access the following functions: Auto registration (after battery replacement), BMS reset, Electric appliance reset, Special function and Battery usage history.

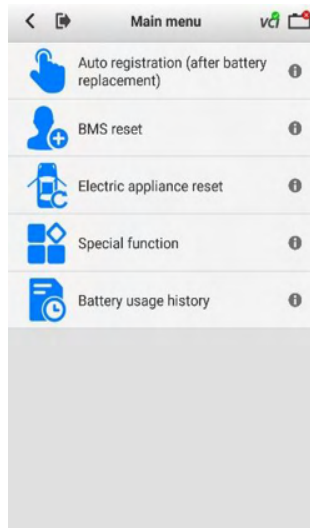

Figure 7-1 Sample Battery Reset Main Menu Screen

## 7.1 Auto Registration (after battery replacement)

Auto registration is often used after the successful installation of a new battery, including BMS reset and Electric appliance reset.

### 7.1.1 BMS Reset

The BMS feature enables you to register a new battery after battery replacement. The BMS Reset function varies by vehicle make. Please follow the on-screen instructions to perform the desired functions.

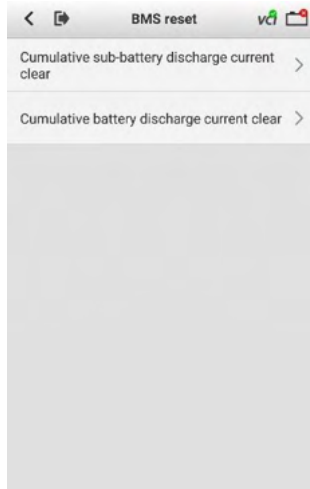

Figure 7-2 Sample BMS Reset Screen

After choosing the desired battery replacement registration, information of Scene, Condition, Influence, and Note will appear. Click **Next** to complete registration.

### 7.1.2 Electric Appliance Reset

When the vehicle power is interrupted when replacing the battery, and a memory saver has not been used, position settings on some vehicle components will be lost. These position limits should be relearned. The functions and related operations in Electric Appliance Reset may vary by

vehicle make. Please follow the on-screen instructions to perform the desired functions.

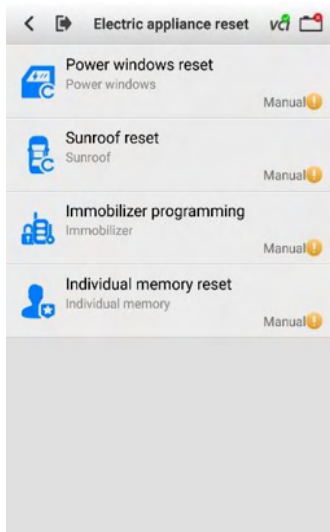

Figure 7-3 Sample Electric Appliance Reset Screen

## 7.2 Special Functions

The special functions vary by vehicle make. Functions other than battery reset are categorized as special functions. Please follow the on-screen instructions to perform the desired function.

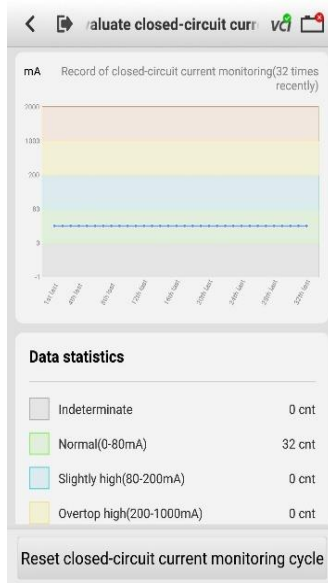

Figure 7-4 Sample “Reset Closed-circuit Current Monitoring Cycle” Screen (BMW vehicles)

## 7.3 Battery Usage History (only for BMW vehicles)

The Battery Usage History function will display the following three tests:

1. SOC (State of Charge) in the last 5 days: monitors the SOC status and diagnoses the health status of the battery.
2. Proportion of SOC duration: displays battery usage habits of drivers.
3. Estimated current mileage comparison (battery replacement): determines the current battery life based on the previous vehicle mileage record.

All three test screens are comprised of three sections:

1. **Main view:** displays data in a waveform or bar graph.
2. **Data description:** provides brief descriptions of the test result.
3. **Suggestion:** offers suggestions on existing problems.



Figure 7-5 Sample SOC in the Last 5 Days Screen



# 8 Diagnostics





The application performs functional tests, retrieves vehicle diagnostic information such as trouble and event codes as well as capturing live data for various vehicle control systems including engine, transmission and ABS.

There are two options available when accessing the Diagnostics section:

1. **Auto Scan** — starts scanning all available systems on the vehicle.
2. **Control Units** — displays a selection menu for all available control units of the vehicle.

After a section is made and the tablet establishes communication with the vehicle, the corresponding function menu or selection menu should appear.

Table 8-1 Top Toolbar Buttons

Button	Description
	Return to the previous page.
	Return to the Diagnostics screen.
	Display VCI connection status.
	Make live data selection by selecting the checkbox. (Available on Live data screen)

## 8.1 Auto Scan

The Auto Scan function performs a comprehensive scan of all the ECUs in the vehicle to detect faults and retrieve DTCs:

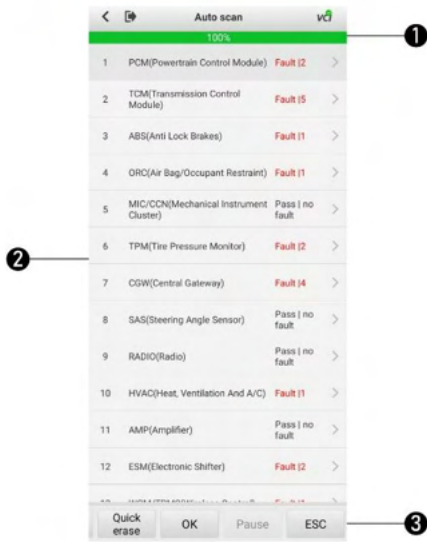

Figure 8-1 Sample Auto Scan Screen

1. Progress Percentage — indicates the test progress
2. Main Section
3. Function Buttons

**Main Section**

Column 1 — displays the sequence numbers.

Column 2 — displays the scanned systems.

Column 3 — displays the diagnostic indicators describing test results.

Indicators are defined as follows:

**Fault | #:** **Fault** indicates fault code(s) detected; **#** indicates the number of the detected faults.

**Pass | no fault:** indicates the system has completed the scanning process with no fault detected.

Column 4 — to perform further diagnosis or testing on a specific system item, tap the > button to the right of that item. A Function Menu screen should appear.

### Function Buttons

A brief description of the operations of the Auto Scan function buttons are displayed in the table below.

Table 8-2 *Auto Scan Function Buttons*

Name	Description
<b>Save</b>	Saves the scanning results as a PDF document.
<b>Report</b>	Displays the diagnostics data in report form.
<b>Quick Erase</b>	Deletes codes. A warning message will display to inform you of possible data loss when this function is selected.
<b>OK</b>	Confirms test results. Continues with system diagnosis after the desired system is selected by tapping the item in the Main Section.
<b>Pause</b>	Suspends scanning. Will change to <b>Continue</b> button after tapping.
<b>ESC</b>	Returns to the previous screen or exits Auto Scan.
<b>Search</b>	Searches related fault code information.

## 8.2 Control Units

Select to directly locate a desired control system for testing. Follow the menu-driven procedures and make proper selection; the application guides the user to the proper Diagnostics function menu based on these selections.

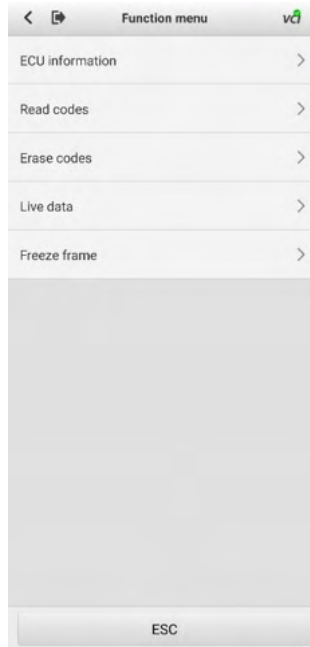

Figure 8-2 *Sample Function Menu Screen*

The Function menu options may vary slightly by vehicle. The Function menu may include:

- **ECU information**
- **Read codes**
- **Erase codes**
- **Live data**
- **Freeze frame**

➤ **To perform a diagnostics function:**

1. Establish communication with the test vehicle.
2. Identify the test vehicle by selecting from the menu options.
3. Select the **Diagnostics** section.
4. Choose **Auto Scan** to locate a desired system or through menu-driven selections in **Control Units**.
5. Select the desired diagnostics function from the **Function menu**.

## 8.2.1 ECU Information

This function retrieves and displays specific information for the tested control unit, including model year, ECU part number and other specifications.

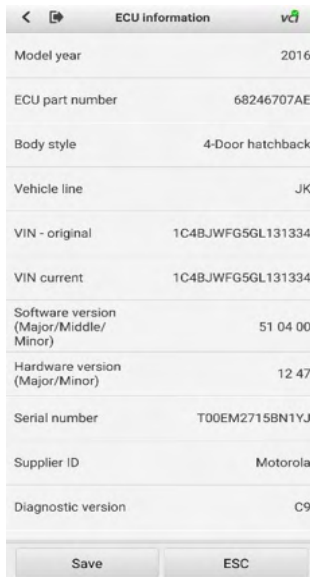

ECU Information	
Model year	2016
ECU part number	68246707AE
Body style	4-Door hatchback
Vehicle line	JK
VIN - original	1C4BJWFG5GL131334
VIN current	1C4BJWFG5GL131334
Software version (Major/Middle/Minor)	51 04 00
Hardware version (Major/Minor)	12 47
Serial number	T00EM2715BN1YJ
Supplier ID	Motorola
Diagnostic version	C9

Save      ESC

Figure 8-3 Sample ECU Information Screen

## 8.2.2 Read Codes

This function retrieves and displays the DTCs from the vehicle's control system. The **Read codes** screen varies by each vehicle tested. Freeze frame data can be viewed if available (snowflake icon indicates data is available).



Figure 8-4 Sample Read Codes Screen

## Main Section

1. Code section — displays the retrieved codes from the vehicle.
2. Description section — describes the retrieved codes in detail.
3. Status section — indicates the status of the retrieved codes.
4. Snowflake icon — only appears when freeze frame data is available for viewing. Selecting this icon will display a data screen, which looks and functions similar to the **Read codes** screen.

## 8.2.3 Erase Codes

After reading the retrieved codes from the vehicle and completing repairs, erase the codes from the vehicle by using this function. Before performing this function, make sure the vehicle's ignition key is in the ON (RUN) position with the engine off.

### ➤ To erase codes

1. Tap **Erase codes** on the Function menu.
2. A message warning of DTCs and (or) freeze data will be deleted should appear.
  - a) Tap **Yes** to continue. A confirmation screen will appear when the operation is successful.
  - b) Tap **No** to exit.
3. Tap **ESC** on the confirmation screen to exit **Erase codes**.
4. Return to the Function menu and tap **Read codes** to verify.

# 9 History

This option stores records of test vehicle history, including battery tests and diagnostics. The diagnostics records also provide test results from previously-tested vehicles and enables the user to restart a diagnostic session by selecting record without the need to perform auto or manual vehicle selection.

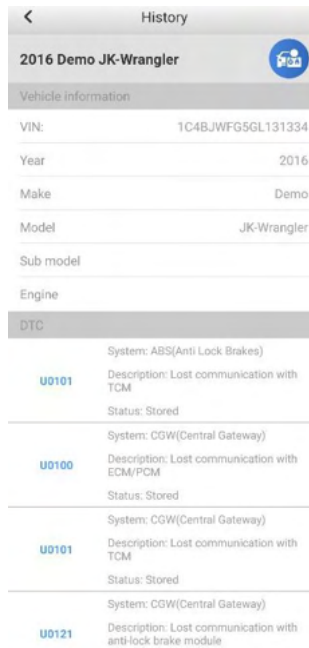

The screenshot displays a mobile application interface for vehicle history. At the top, there is a back arrow and the title 'History'. Below this, the vehicle is identified as '2016 Demo JK-Wrangler' with a blue circular icon containing a car silhouette. A section titled 'Vehicle information' lists the following details: VIN: 1C4BJWFG5GL131334, Year: 2016, Make: Demo, Model: JK-Wrangler, Sub model, and Engine. Below this, a section titled 'DTC' lists four diagnostic trouble codes with their respective system, description, and status.

Vehicle information	
VIN:	1C4BJWFG5GL131334
Year	2016
Make	Demo
Model	JK-Wrangler
Sub model	
Engine	

DTC	
U0101	System: ABS(Anti Lock Brakes) Description: Lost communication with TCM Status: Stored
U0100	System: CGW(Central Gateway) Description: Lost communication with ECM/PCM Status: Stored
U0101	System: CGW(Central Gateway) Description: Lost communication with TCM Status: Stored
U0121	System: CGW(Central Gateway) Description: Lost communication with anti-lock brake module

Figure 9-1 Sample Diagnostics Test Records Screen



# 10 Mall

The **Mall** provides users with a quick access to the app's built-in store for purchasing vehicle diagnostic packages. Please enter your Autel ID and link the MaxiBAS BT508 device to your account. Three vehicle software sets (Battery Test, Eobd and Demo) are free and available for the life of the tool. Download them and all systems diagnostics software for vehicle brand of your choice through the **Mall** after the initial linking of the VCI to your account.

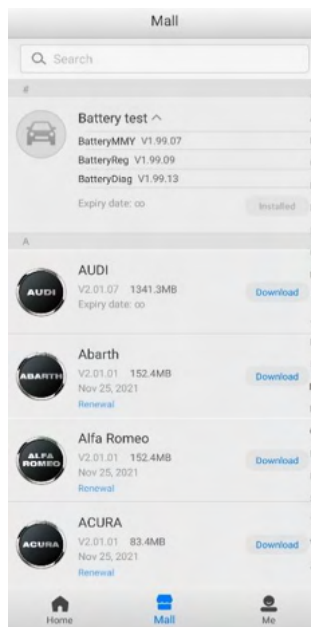

Figure 10-1 Sample Mall screen

1. Tap the **Mall** button on the **Home** screen. A list of vehicle brands sorted by alphabet will display.
  2. The corresponding price of each app is displayed on the right side of the software. Tap the price of the desired app to view the detail screen, with more information about the app.
  3. Tap **Buy Now** to purchase.
- 

 **NOTE**

Your purchased software are available for one year. You can renew them after their expiration.

---

# 11 Me

In this section, users have access to functions including Order Manager, Repair Reports, Delete Vehicle, Data Logging, VCI Manager, BAS Manager, Settings, and User Manual.

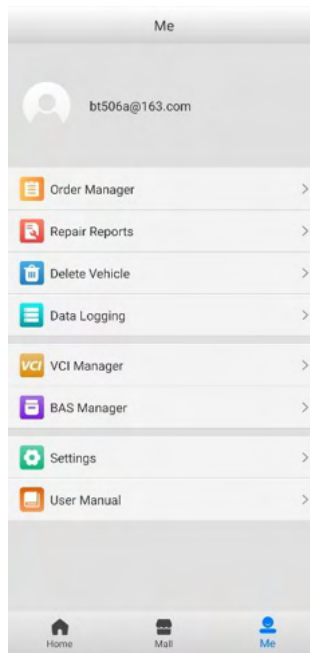

Figure 11-1 *Sample Me Screen*

The above functions are available only after registration.

➤ **To complete registration:**

1. Tap the **Register** button on the **Log in** screen.
2. Enter your email address. Tap the **Verification code** button and an email will be sent to your address with your unique verification code. Enter the verification code and your account password on the registration screen.
3. Tap **Register** to complete the registration.

## 11.1 Order Manager

This function can help you manage orders efficiently.

---

 **NOTE**

Purchased vehicle software cannot be shared between Android and iOS platforms. Software purchased on an Android device will not be available on an iOS device and vice versa.

---

## 11.2 Repair Reports

The Battery Test app can save a history of scan reports from your diagnostic sessions. A PDF can also be generated for the easy viewing, sharing, and printing of these reports.

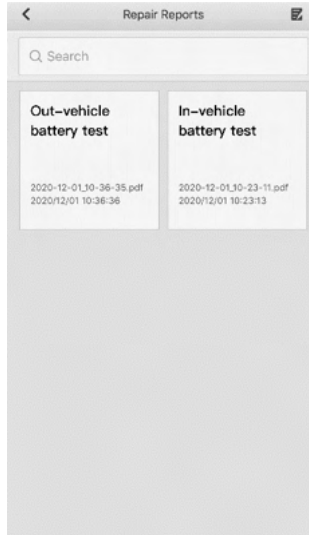



Figure 11-2 Sample Repair Reports Screen

Tap  button on the top-right corner of the screen to delete the selected data.

## 11.3 Delete Vehicle

This option allows you to delete vehicle files from the unit.

## 11.4 Data Logging

The Data Logging option allows you to launch the Autel Support platform to view all recordings on the diagnostic system. The Data Logging option keeps all test records, whether submitted (**Feedback**) or not submitted (**Not**

**Feedback**), in addition to a history of your most recent 20 test records (**History**). Autel support personnel will receive and process any submitted reports through the Support platform.

## 11.5 VCI Manager

VCI Manager is for connecting the MaxiBAS BT508 with a VCI device via Bluetooth. This option allows you to pair the tester with the VCI device, check the communication status, and upgrade the VCI firmware.

## 11.6 BAS Manager

The BAS Manager allows you to establish a Bluetooth connection, and to check and update the firmware version.

---

 **NOTE**

When initiating a diagnostic function, the screen will display a notification message to prompt the user to update the firmware if a newer version is available.

---

## 11.7 Settings

Select the **Settings** to change the default settings, clear cache, and view hardware and software information relating to the tool.

## **Unit**

**English** or **Metric** measurements can be used. By default, **Metric** is chosen. Tap **English** to have the tool display measures in **English** units.

## **Tips Reset**

Reset the tips feature to turn on the on-screen guidance when using your unit.

# **11.8 User Manual**

This option launches the User Manual for the MaxiBAS BT508.

# 12 Maintenance and Service

This chapter describes problems that you may encounter while using the MaxiBAS BT508. Battery usage and service information is also introduced.

## 12.1 Maintenance Instructions

The following shows how to maintain your device, together with precautions to take.

- Do not use any abrasive cleansers, detergents, or automotive chemicals on the tester.
- Maintain all devices in dry conditions and keep them within normal operating temperatures.
- Do not store the devices in humid, dusty or dirty areas.
- Check the housing, wiring, and connectors for dirt and damage before and after each use.
- At the end of each work day, wipe the device housing, wiring, and connectors clean with a damp cloth.
- Do not attempt to disassemble the tester.
- Do not drop or cause severe impact to the device.
- Use only authorized battery chargers and accessories. Any malfunction or damage caused by the use of unauthorized battery chargers and accessories will void the product warranty.
- Ensure that the battery charger does not come in contact with conductive objects.



## 12.2 Troubleshooting Checklist

### A. When the tester does not work properly:

- Make sure the app system and diagnostic application software are properly updated.
- Check all cables, connections, and indicators to ensure the signal is being received.

### B. When you are unable to charge the tester:

- Check the connections.
- Ensure you are using the power supply included with the tool.
- Ensure the tool is being charged in a room of moderate temperature, not too hot or too cold.
- Contact technical support or your authorized Autel supplier if the unit or charger is damaged.

### C. When Bluetooth connection fails:

- The Bluetooth signal is out of range. Move the battery tester closer to your mobile device.
- You may remove the VCI from the vehicle's DLC and insert it again, and turn off Bluetooth on your mobile device and turn it on again (and / or turn off your mobile device and turn it on again).

---

#### NOTE

If the problems persist, please contact Autel technical support personnel or your local distributor.

---

## 12.3 About Battery Usage

Your tester is powered by a built-in Lithium-ion Polymer battery. This means that, unlike other battery technologies, the battery can be recharged with some remaining battery life without damaging its longevity.

---

 **DANGER**

1. The built-in Lithium-ion Polymer battery is factory replaceable only; incorrect replacement or tampering with the battery pack may cause an explosion.
  2. Do not use a damaged battery charger.
- 

- Do not disassemble or open, crush, bend or deform, puncture or shred.
- Do not modify or remanufacture, attempt to insert foreign objects into the battery, expose to fire, explosion or other hazards.
- Make sure to use the charger and USB cables that come together in the package only. If you use the other charger and USB cables, you might incur malfunction or failure of the device.
- Only use the charging device that has been qualified with device per the standard. Use of an unqualified battery or charger may present a risk of fire, explosion, leakage, or other hazards.
- Avoid dropping the tester. If the tester is dropped, especially on a hard surface, and the user suspects damage, contact support.
- The battery recharging time varies depending on the remaining battery capacity.
- Battery life inevitably shortens over time.
- Since over charging may shorten battery life, remove the tester from its charger once it is fully charged. Unplug the charger once charging is complete.
- Leaving the tester in hot or cold places, especially inside a car in summer or winter, may reduce the capacity and life of the battery. Always keep the battery within normal temperatures.

## 12.4 Service Procedures

This section introduces information for technical support, repair service, and application for replacement or optional parts.

### 12.4.1 Technical Support

If you have any question or problem on the operation of the product, please contact us.

#### AUTEL NORTH AMERICA

- **Phone:** 1-855-AUTEL-US (288-3587) (855-288-3587) Monday-Friday 9am-6pm EST
- **Website:** [www.autel.com](http://www.autel.com)
- **Email:** [ussupport@autel.com](mailto:ussupport@autel.com)
- **Address:** 175 Central Avenue, Suite 200, Farmingdale, New York, USA 11735

#### AUTEL EUROPE

- **Phone:** 0049 (0) 6103-2000520 (Monday-Friday, 9:00AM-6:00PM Berlin Time)
- **Website:** [www.autel.eu](http://www.autel.eu)
- **Email:** [sales.eu@autel.com](mailto:sales.eu@autel.com), [support.eu@autel.com](mailto:support.eu@autel.com)
- **Address:** Adalperostraße 82, 85737 Ismaning, Germany

#### AUTEL CHINA HQ

- **Phone:** 0086-755-2267-2493 (Monday-Friday, 9:00AM-6:00PM Beijing Time)
- **Website:** [www.autel.com](http://www.autel.com)
- **Email:** [support@autel.com](mailto:support@autel.com)
- **Address:** 7th, 8th and 10th floor, Building B1, Zhiyuan, Xueyuan Road, Xili, Nanshan, Shenzhen, 518055, China.

#### AUTEL LATIN AMERICA

- **Website:** [www.autel.com](http://www.autel.com)
- **Email:** [sales.latin@autel.com](mailto:sales.latin@autel.com), [latsupport02@autel.com](mailto:latsupport02@autel.com)
- **Address:** Avenida Americas 1905, 6B, Colonia Aldrete, Guadalajara, Jalisco, Mexico

#### AUTEL APAC

- **Phone:** +045 5948465
- **Website:** [www.autel.com/jp/](http://www.autel.com/jp/)
- **Email:** [sales.jp@autel.com](mailto:sales.jp@autel.com), [support.jp@autel.com](mailto:support.jp@autel.com)
- **Address:** 719, Nissou Building, 3-7-18, Shinyokohama, Kouhoku, Yokohama, Kanagawa, Japan 222-0033

#### Autel IMEA DMCC

- **Phone:** +971 585 002709

- **Website:** [www.autel.com](http://www.autel.com)
- **Email:** [sales.imea@autel.com](mailto:sales.imea@autel.com), [imea-support@autel.com](mailto:imea-support@autel.com)
- **Address:** Office 1006-1010, Cluster C, Fortune Tower, Jumeirah Lakes Tower (JLT), Dubai, U.A.E

For technical assistance in other markets, please contact your local distributor.

## 12.4.2 Repair Service

If it becomes necessary to return your device for repair, please download the repair service form from [www.autel.com](http://www.autel.com), and fill in the form. The following information must be included:

- Contact name
- Return address
- Telephone number
- Product name
- Complete description of the problem
- Proof-of-purchase for warranty repairs
- Preferred method of payment for non-warranty repairs

---

 **NOTE**

For non-warranty repairs, payment can be made with Visa, Master Card, or with approved credit terms.

---

Send the device to your local distributor, or to the below address:

7th, 8th and 10th Floor, Building B1, Zhiyuan, Xueyuan Road, Xili, Nanshan, Shenzhen, 518055, China

# 13 Compliance Information

## FCC Compliance

FCC ID: WQ8BATS-BT508

This device complies with part 15 of the FCC Rules. Operation is subject to the following two conditions:

- a) This device may not cause harmful interference, and
- b) This device must accept any interference received, including interference that may cause undesired operation.

---

### **WARNING**

Changes or modifications not expressly approved by the party responsible for compliance could void the user's authority to operate the equipment.

---

### **NOTE**

This equipment has been tested and found to comply with the limits for a Class B digital device, pursuant to Part 15 of the FCC Rules. These limits are designed to provide reasonable protection against harmful interference in a residential installation.

---

This equipment generates uses and can radiate radio frequency energy and, if not installed and used in accordance with the instructions, may cause harmful interference to radio communications. However, there is no guarantee that interference will not occur in a particular installation. If this equipment does cause harmful interference to radio or television reception, which can be determined by turning the equipment off and on, the user is encouraged to try to correct the interference by one or more of the following measures:

-- Reorient or relocate the receiving antenna.

- Increase the separation between the equipment and receiver.
- Connect the equipment into an outlet on a circuit different from that to which the receiver is connected.
- Consult the dealer or an experienced radio/TV technician for help.

### **FCC Radiation Exposure Statement**

This equipment complies with FCC radiation exposure limits set forth for an uncontrolled environment. This equipment should be installed and operated with minimum distance 20cm between the radiator & your body.

### **RF Warning Statement**

The device has been evaluated to meet general RF exposure requirement. The device can be used in portable exposure condition without restriction. RF ETSIEN300328 V2.2.2 (2019-07)

### **RoHS COMPLIANCE**

This device is declared to be in compliance with the European RoHS Directive 2011/65/EU and Directive (EU) 2015/863. IEC62321

### **CE COMPLIANCE**

This product is declared to conform to the essential requirements of the following Directives and carries the CE mark accordingly:

EMC ETSIEN301489-1 V2.2.3 (2019-11) ETSIEN301489-17 V3.1.1 (2017-02)

Safety EN62368-1: 2014+A11: 2017

Health EN50663: 2017: EN62479: 2010

Directive 2014/53/EU



# 14 Warranty

## Limited One Year Warranty

Autel Intelligent Technology Corp., Ltd. (the Company) warrants to the original retail purchaser of this MaxiBAS battery tester, that should this product or any part thereof during normal consumer usage and conditions, be proven defective in material or workmanship that results in product failure within one (1) year period from the date of purchase, such defect(s) will be repaired, or replaced (with new or rebuilt parts) with Proof of Purchase, at the Company's option, without charge for parts or labor directly related to the defect(s).

The Company shall not be liable for any incidental or consequential damages arising from the use, misuse, or mounting of the device. Some states do not allow limitation on how long an implied warranty lasts, so the above limitations may not apply to you.

### **This warranty does not apply to:**

- a) Products subjected to abnormal use or conditions, accident, mishandling, neglect, unauthorized alteration, misuse, improper installation or repair or improper storage;
- b) Products whose mechanical serial number or electronic serial number has been removed, altered or defaced;
- c) Damage from exposure to excessive temperatures or extreme environmental conditions;
- d) Damage resulting from connection to, or use of any accessory or other product not approved or authorized by the Company;
- e) Defects in appearance, cosmetic, decorative or structural items such as framing and non-operative parts.
- f) Products damaged from external causes such as fire, dirt, sand, battery leakage, blown fuse, theft or improper usage of any electrical source.



---

**! IMPORTANT**

All contents of the product may be deleted during the process of repair. You should create a back-up copy of any contents of your product before delivering the product for warranty service.

---